

LMS20-24
 SCALE: 1" = 1'-0"
 WEIGHT: 92#
TIER 5 RATED

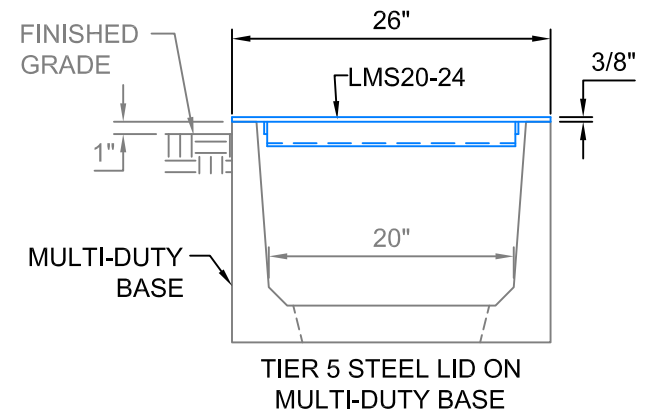

Trenwa Inc.	
1419 ALEXANDRIA PIKE FORT THOMAS, KY 41075 859-781-0831	
TIER 5 STEEL LID & SECTION FOR 20" WIDE MULTI-DUTY TRENCH	
Date: 3/13/17	Dwg. No. LMS20-24