

LMA24-60

SCALE: 1"=1'-0"

WEIGHT: 95#

TIER 5 RATED

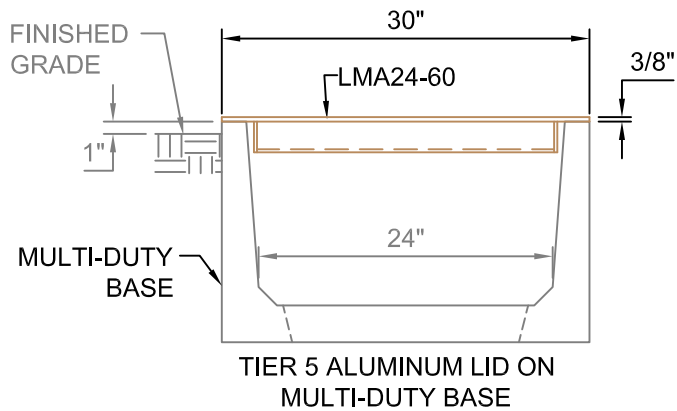

Trenwa Inc.

1419 ALEXANDRIA PIKE FORT THOMAS, KY 41075 859-781-0831

TIER 5 ALUMINUM LID & SECTION FOR 24" WIDE MULTI-DUTY TRENCH

Date:
2/28/17

Dwg. No.
LMA24-60