

LHC7218-120
SCALE: 1/2"=1'-0"

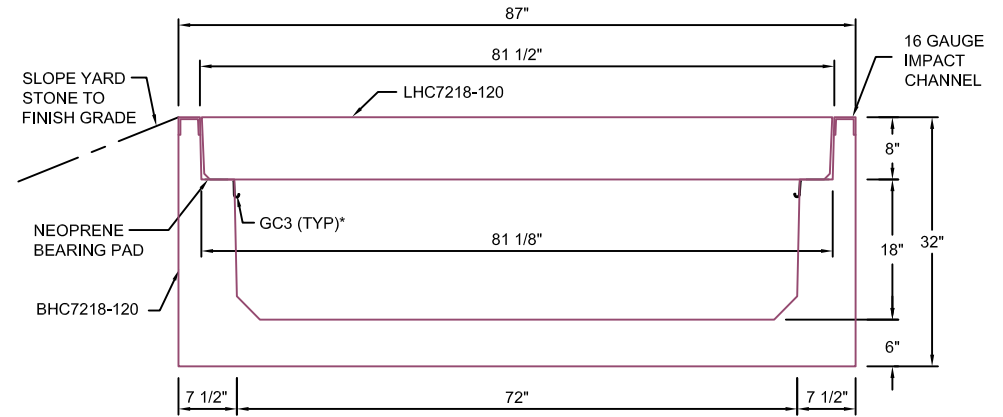

TYPICAL ROAD CROSSING SECTION 72"W x 18"D

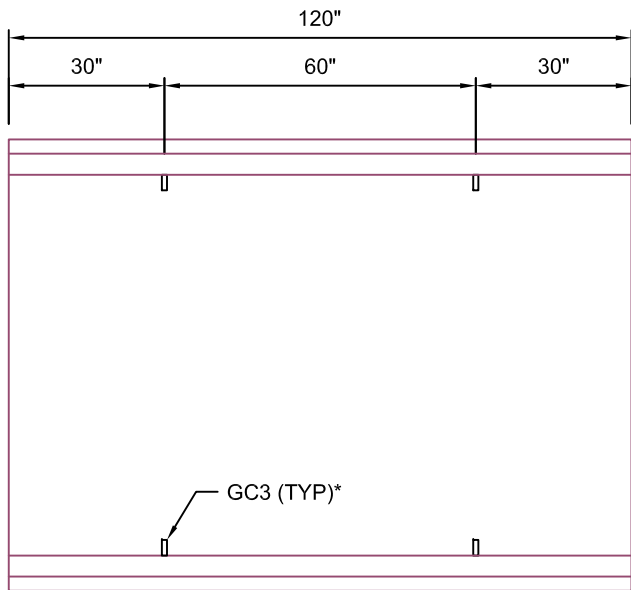

BHC7218-120
SCALE: 1/2"=1'-0"

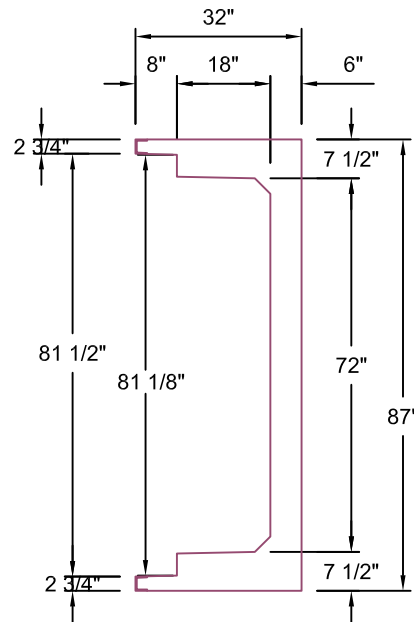

**AASHTO HS20 DESIGN
(32,000 LBS / AXLE)**

*GC3 (GROUND CLIPS) OPTIONAL

Trenwa Inc.	
1419 ALEXANDRIA PIKE FORT THOMAS, KY 41075 859-781-0831	
TYPICAL ROAD CROSSING BASE, LID & SECTION FOR 72" WIDE x 18" DEEP TRENCH	
Date: 6/12/2013 bd	Dwg. No. BHC7218-120 STD