

LHC3048-120
SCALE: 1/2"=1'-0"

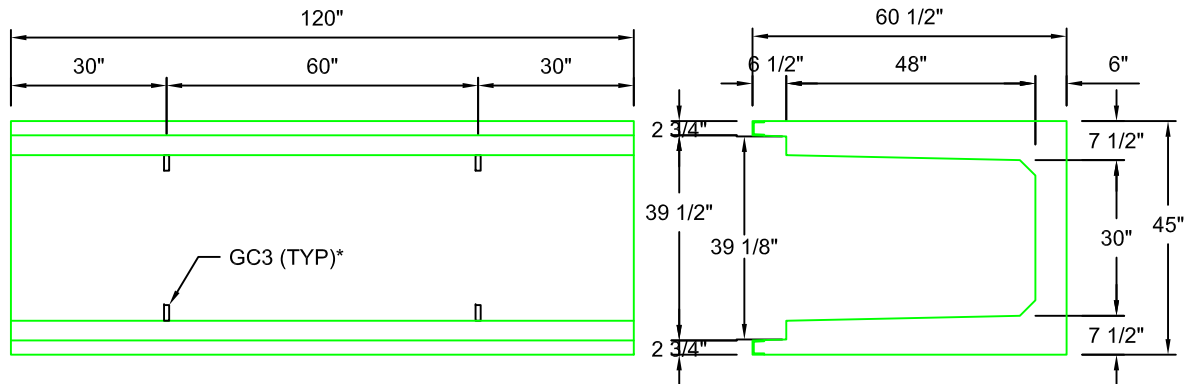

BHC3048-120
SCALE: 1/2"=1'-0"

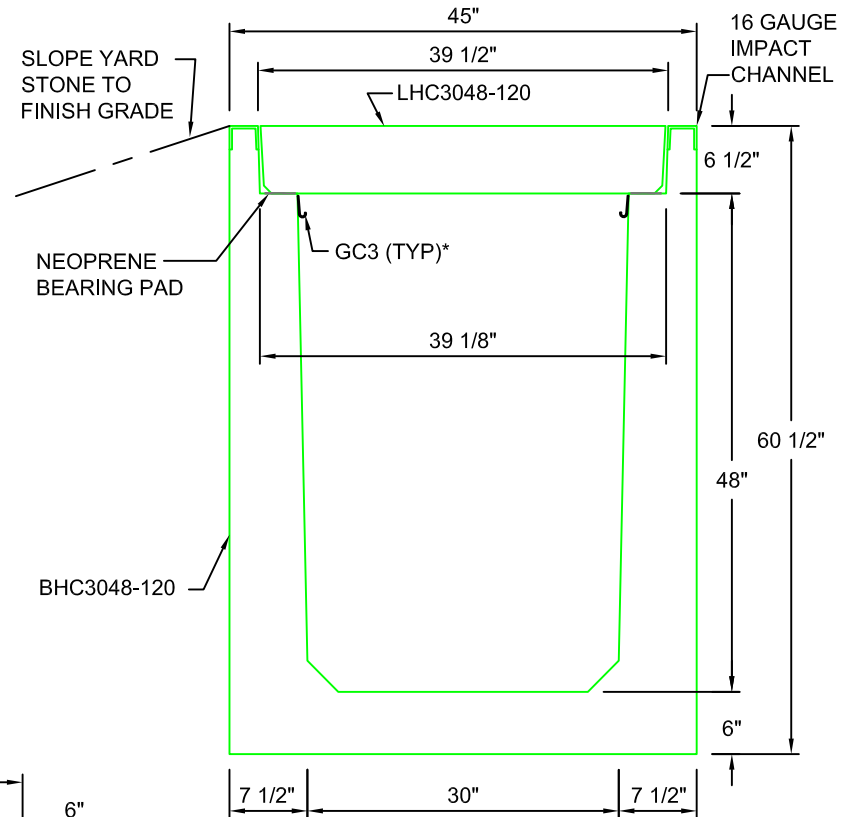

TYPICAL ROAD CROSSING
SECTION 30"W x 48"D
SCALE: 1"=1'-0"

AASHTO HS20 DESIGN
(32,000 LBS / AXLE)

Trenwa Inc.

1419 ALEXANDRIA PIKE FORT THOMAS, KY 41075 859-781-0831

TYPICAL ROAD CROSSING BASE, LID & SECTION FOR 30" WIDE x 48" DEEP TRENCH

Date:
9/18/12

Dwg. No.
BHC3048-120

*GC3 (GROUND CLIPS) OPTIONAL