

LHS48-15
SCALE: 3/4"=1'-0"
WEIGHT: 210 #

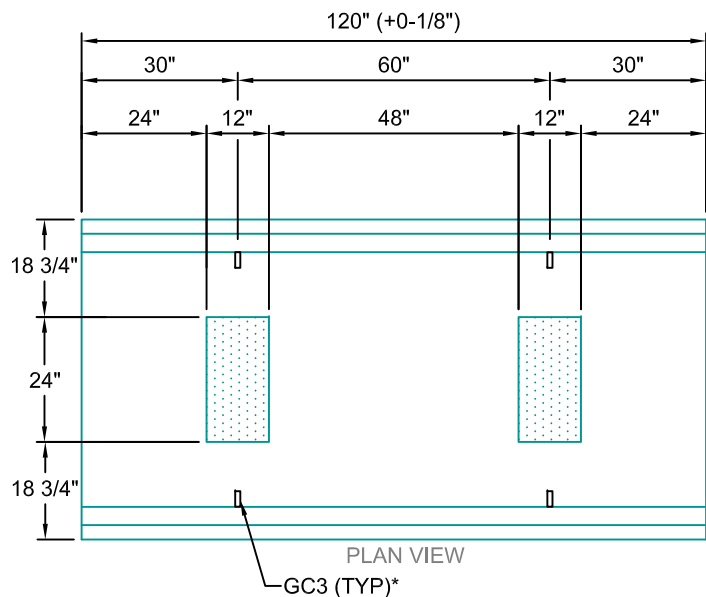

BHS4812-120
SCALE: 1/2" = 1'-0"
WEIGHT: 4215 #

*GC3 (GROUND CLIPS) OPTIONAL

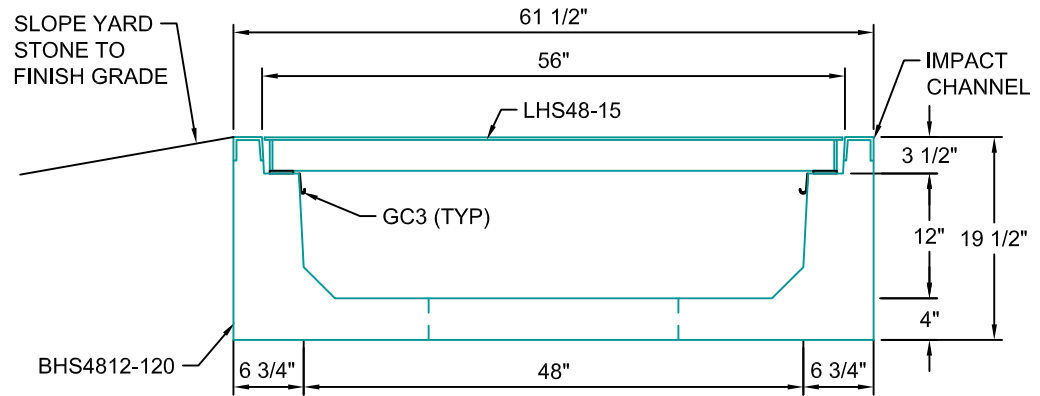

TYPICAL ROAD CROSSING SECTION WITH STEEL LID

48"W x 12"D

SCALE: 1"=1'-0"

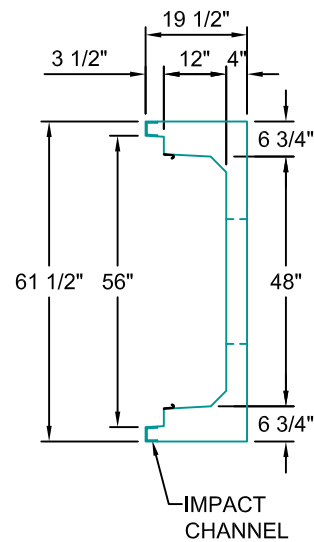

AASHTO HS20 DESIGN
(32,000 LBS / AXLE)

Trenwa Inc.	
1419 ALEXANDRIA PIKE FORT THOMAS, KY 41075 859-781-0831	
TYPICAL ROAD CROSSING BASE, STEEL LID & SECTION FOR 48" WIDE x 12" DEEP TRENCH	
Date: 3/9/17	Dwg. No. BHS4812-120